

PROJECT	_____
TYPE	_____
SPECIFIER	_____
QUANTITY	_____
DATE	_____

HARMONY SQUARE SUSPENSION

A51075-

base number	Color	Finish	Diffuser
	Temperature	Options	Options

- To build a product code in our configurator select the specify button on the base model # product page
- To build a manual product code on this datasheet choose from the options listed below in blue font and add the suffix to the base model #

GENERAL

Series: Harmony Square
Partner: Ivela
Division: Architectural
Installation: Suspension
Product Type: Panels
Mounting Location: Ceiling
Light Distribution: Direct

PHYSICAL

Shape: Square
Length (mm): 610
Length (in): 24
Width (mm): 610
Width (in): 24
Height (mm): 27
Height (in): 1 1/16
Max. Overall Height (mm): 2500
Max. Overall Height (in): 98 7/16
Diffuser: PMMA - Opal / Prismatic
Fixture Finish: WHI / BLK / GLD
Fixture Material: Aluminum

ELECTRICAL

Lamp Type: LED
Input Wattage (W): 48
Dimming: Tri-Mode (Non-Dimming and Phase Dimming (120Vac only) and 0-10V Dimming)
Driver Included: No
Driver Location: Remote
Driver Type: Constant Voltage - Universal
Driver Class: Class 2
Housing: ENCP 5 (ERP) ENCP 13 (SC Power)
Input Voltage (V): 120 - 277
Output Voltage (V): 24

LED

Color Temperature (°K): 2700 / 3000 / 3500 / 4000
Max. Delivered Lumen (lm): 3456 / 3600 / 3707 / 3816
Nominal Lumen (lm): 5760 / 6000 / 6360
CRI: >93 CRI
Lamp Life (hrs): 50000

OPTICAL

RATINGS AND CERTIFICATIONS

Certified By: Certified for North American Standards
IP rating: IP20



HARMONY SQUARE SUSPENSION

A51075-

PROJECT _____

TYPE _____

SPECIFIER _____

QUANTITY _____

DATE _____



PROJECT	_____
TYPE	_____
SPECIFIER	_____
QUANTITY	_____
DATE	_____

HARMONY SQUARE SUSPENSION

A51076-

base number	Color	Finish	Diffuser
	Temperature	Options	Options

- To build a product code in our configurator select the specify button on the base model # product page
- To build a manual product code on this datasheet choose from the options listed below in blue font and add the suffix to the base model #

GENERAL

Series: Harmony Square
 Partner: Ivela
 Division: Architectural
 Installation: Suspension
 Product Type: Panels
 Mounting Location: Ceiling
 Light Distribution: Direct

PHYSICAL

Shape: Square
 Length (mm): 910
 Length (in): 35 ¹³/₁₆"
 Width (mm): 910
 Width (in): 35 ¹³/₁₆"
 Height (mm): 27
 Height (in): 1 ¹/₁₆"
 Max. Overall Height (mm): 2500
 Max. Overall Height (in): 98 ⁷/₁₆"
 Diffuser: PMMA - Opal / Prismatic
 Fixture Finish: WHI / BLK / GLD
 Fixture Material: Aluminum

ELECTRICAL

Lamp Type: LED
 Input Wattage (W): 48
 Dimming: Tri-Mode (Non-Dimming and Phase Dimming (120Vac only) and 0-10V Dimming)
 Driver Included: No
 Driver Location: Remote
 Driver Type: Constant Voltage - Universal
 Driver Class: Class 2
 Housing: ENCP 5 (ERP) ENCP 8 (SC Power)
 Input Voltage (V): 120 - 277
 Output Voltage (V): 24

LED

Color Temperature (°K): 2700 / 3000 / 3500 / 4000
 Max. Delivered Lumen (lm): 5184 / 5400 / 5560 / 5724
 Nominal Lumen (lm): 8640 / 9000 / 9540
 CRI: >93 CRI
 Lamp Life (hrs): 50000

OPTICAL

RATINGS AND CERTIFICATIONS

Certified By: Certified for North American Standards
 IP rating: IP20

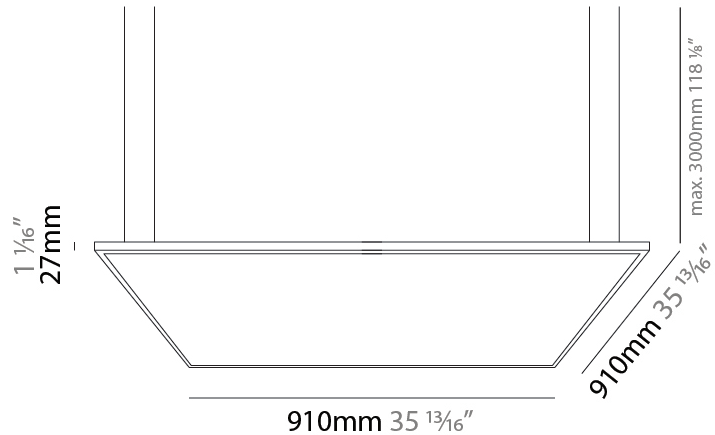

HARMONY SQUARE SUSPENSION

A51076-

PROJECT

TYPE

SPECIFIER

QUANTITY

DATE

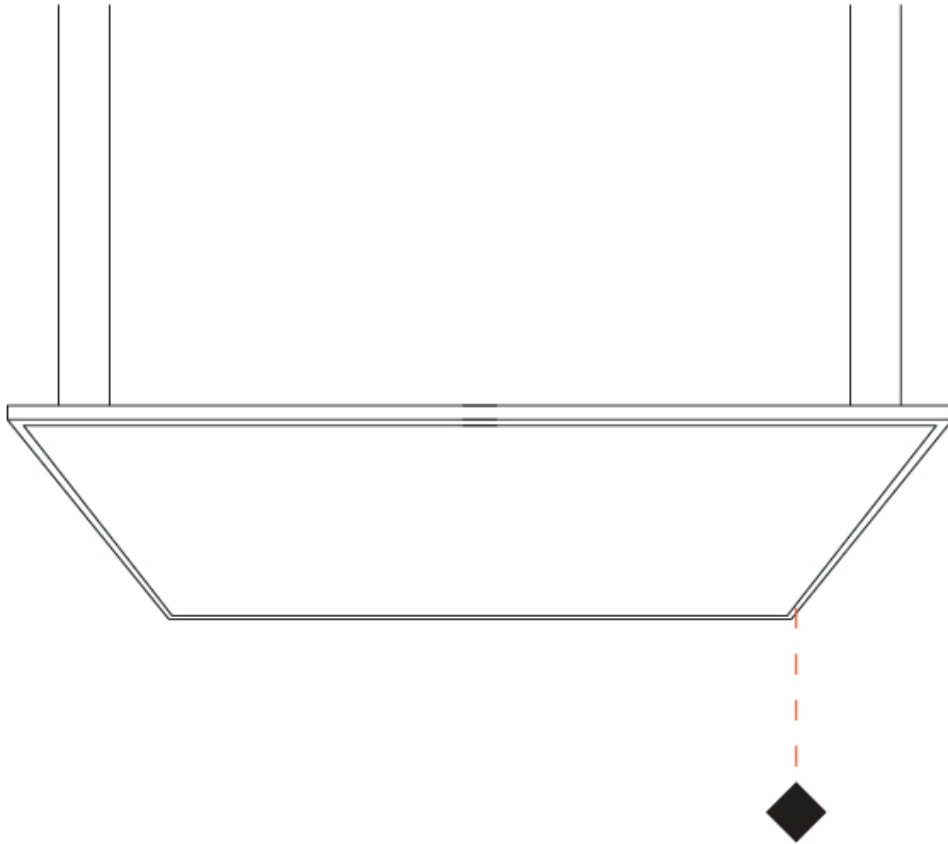

A

PROJECT	_____
TYPE	_____
SPECIFIER	_____
QUANTITY	_____
DATE	_____

HARMONY SQUARE SUSPENSION

A51077-

base number	Color	Finish	Diffuser
	Temperature	Options	Options

- To build a product code in our configurator select the specify button on the base model # product page
- To build a manual product code on this datasheet choose from the options listed below in blue font and add the suffix to the base model #

GENERAL

Series: Harmony Square
Partner: Ivela
Division: Architectural
Installation: Suspension
Product Type: Panels
Mounting Location: Ceiling
Light Distribution: Direct

PHYSICAL

Shape: Square
Length (mm): 1110
Length (in): 43 11/16
Width (mm): 1110
Width (in): 43 11/16
Height (mm): 27
Height (in): 1 1/16
Max. Overall Height (mm): 2500
Max. Overall Height (in): 98 7/16
Diffuser: PMMA - Opal / Prismatic
Fixture Finish: WHI / BLK / GLD
Fixture Material: Aluminum

ELECTRICAL

Lamp Type: LED
Input Wattage (W): 80
Dimming: Tri-Mode (Non-Dimming and Phase Dimming (120Vac only) and 0-10V Dimming)
Driver Included: No
Driver Location: Remote
Driver Type: Constant Voltage - Universal
Driver Class: Class 2
Housing: ENCP 5 (ERP) ENCP 13 (SC Power)
Input Voltage (V): 120 - 277
Output Voltage (V): 24

LED

Color Temperature (°K): 2700 / 3000 / 3500 / 4000
Max. Delivered Lumen (lm): 6336 / 6600 / 6796 / 6996
Nominal Lumen (lm): 10560 / 11000 / 11660
CRI: >93 CRI
Lamp Life (hrs): 50000

OPTICAL

RATINGS AND CERTIFICATIONS

Certified By: Certified for North American Standards
IP rating: IP20

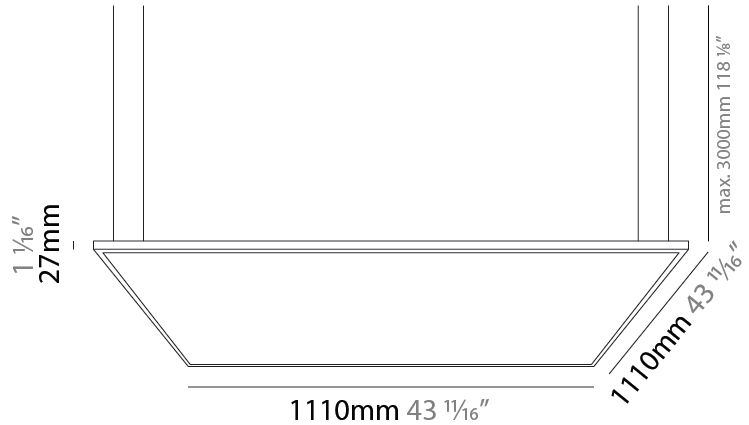

HARMONY SQUARE SUSPENSION

A51077-

PROJECT _____

TYPE _____

SPECIFIER _____

QUANTITY _____

DATE _____

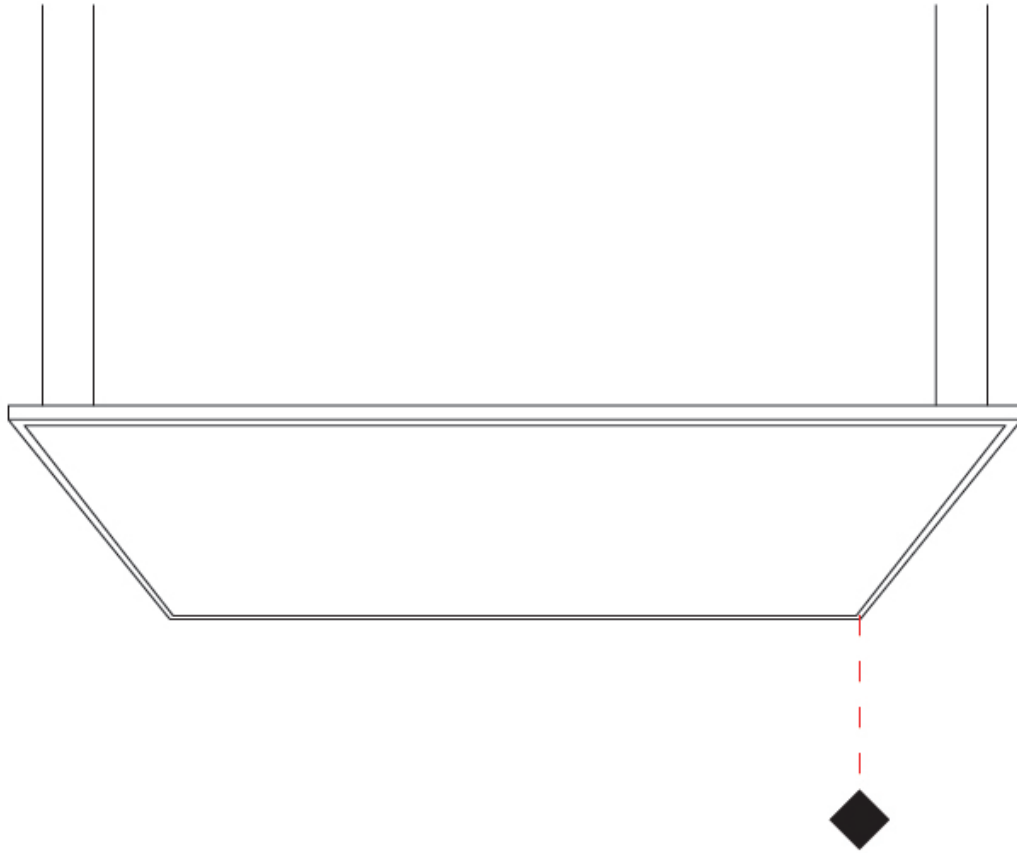

PROJECT	_____
TYPE	_____
SPECIFIER	_____
QUANTITY	_____
DATE	_____

HARMONY SQUARE SUSPENSION

A51078-

base number	Color	Finish	Diffuser
	Temperature	Options	Options

- To build a product code in our configurator select the specify button on the base model # product page
- To build a manual product code on this datasheet choose from the options listed below in blue font and add the suffix to the base model #

GENERAL

Series: Harmony Square
Partner: Ivela
Division: Architectural
Installation: Suspension
Product Type: Panels
Mounting Location: Ceiling
Light Distribution: Direct

PHYSICAL

Shape: Square
Length (mm): 1210
Length (in): 47 5/8
Width (mm): 610
Width (in): 24
Height (mm): 27
Height (in): 1 1/16
Max. Overall Height (mm): 2500
Max. Overall Height (in): 98 7/16
Diffuser: PMMA - Opal / Prismatic
Fixture Finish: WHI / BLK / GLD
Fixture Material: Aluminum

ELECTRICAL

Lamp Type: LED
Input Wattage (W): 48
Dimming: Tri-Mode (Non-Dimming and Phase Dimming (120Vac only) and 0-10V Dimming)
Driver Included: No
Driver Location: Remote
Driver Type: Constant Voltage - Universal
Driver Class: Class 2
Housing: ENCP 5 (ERP) ENCP 13 (SC Power)
Input Voltage (V): 120 - 277
Output Voltage (V): 24

LED

Color Temperature (°K): 2700 / 3000 / 3500 / 4000
Max. Delivered Lumen (lm): 3456 / 3600 / 3707 / 3816
Nominal Lumen (lm): 5760 / 6000 / 6360
CRI: >93 CRI
Lamp Life (hrs): 50000

OPTICAL

RATINGS AND CERTIFICATIONS

Certified By: Certified for North American Standards
IP rating: IP20

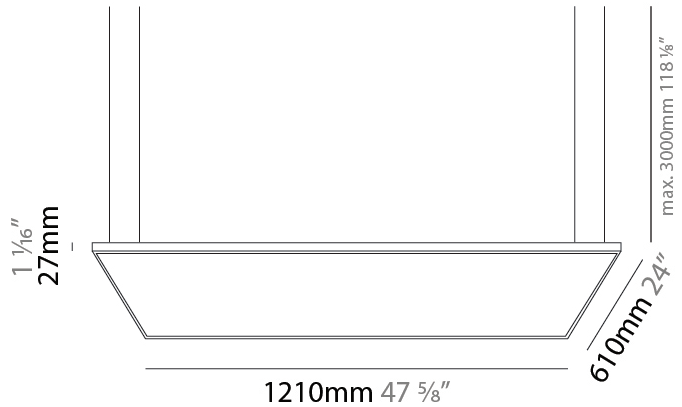

HARMONY SQUARE SUSPENSION

A51078-

PROJECT _____

TYPE _____

SPECIFIER _____

QUANTITY _____

DATE _____

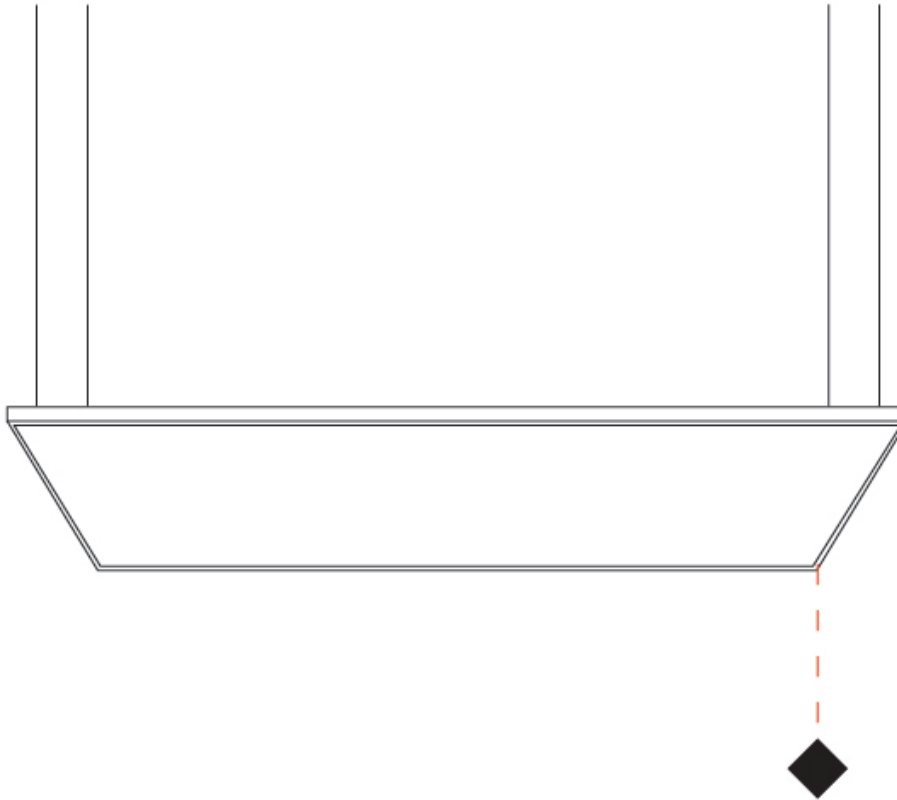

PROJECT	_____
TYPE	_____
SPECIFIER	_____
QUANTITY	_____
DATE	_____

HARMONY SQUARE SUSPENSION

A51079-

base number	Color	Finish	Diffuser
	Temperature	Options	Options

- To build a product code in our configurator select the specify button on the base model # product page
- To build a manual product code on this datasheet choose from the options listed below in blue font and add the suffix to the base model #

GENERAL

Series: Harmony Square
Partner: Ivela
Division: Architectural
Installation: Suspension
Product Type: Panels
Mounting Location: Ceiling
Light Distribution: Direct

PHYSICAL

Shape: Square
Length (mm): 1510
Length (in): 59 7/16
Width (mm): 910
Width (in): 35 13/16
Height (mm): 27
Height (in): 1 1/16
Max. Overall Height (mm): 2500
Max. Overall Height (in): 98 7/16
Diffuser: PMMA - Opal / Prismatic
Fixture Finish: WHI / BLK / GLD
Fixture Material: Aluminum

ELECTRICAL

Lamp Type: LED
Input Wattage (W): 60
Dimming: Tri-Mode (Non-Dimming and Phase Dimming (120Vac only) and 0-10V Dimming)
Driver Included: No
Driver Location: Remote
Driver Type: Constant Voltage - Universal
Driver Class: Class 2
Housing: ENCP 5 (ERP) ENCP 8 (SC Power)
Input Voltage (V): 120 - 277
Output Voltage (V): 24

LED

Color Temperature (°K): 2700 / 3000 / 3500 / 4000
Max. Delivered Lumen (lm): 4320 / 4500 / 4634 / 4770
Nominal Lumen (lm): 7200 / 7500 / 7950
CRI: >93 CRI
Lamp Life (hrs): 50000

OPTICAL

RATINGS AND CERTIFICATIONS

Certified By: Certified for North American Standards
IP rating: IP20

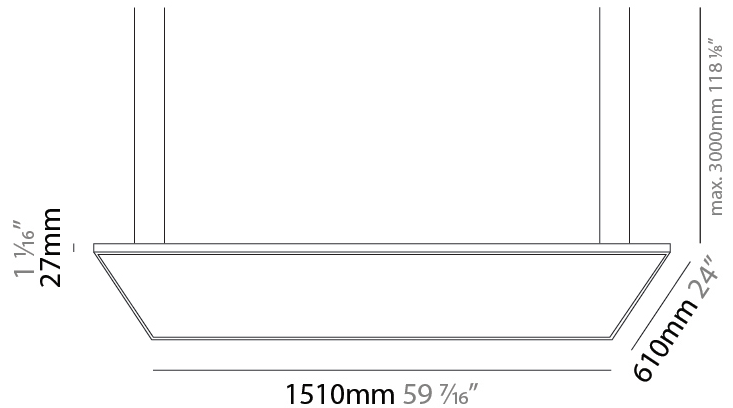

HARMONY SQUARE SUSPENSION

A51079-

PROJECT _____

TYPE _____

SPECIFIER _____

QUANTITY _____

DATE _____

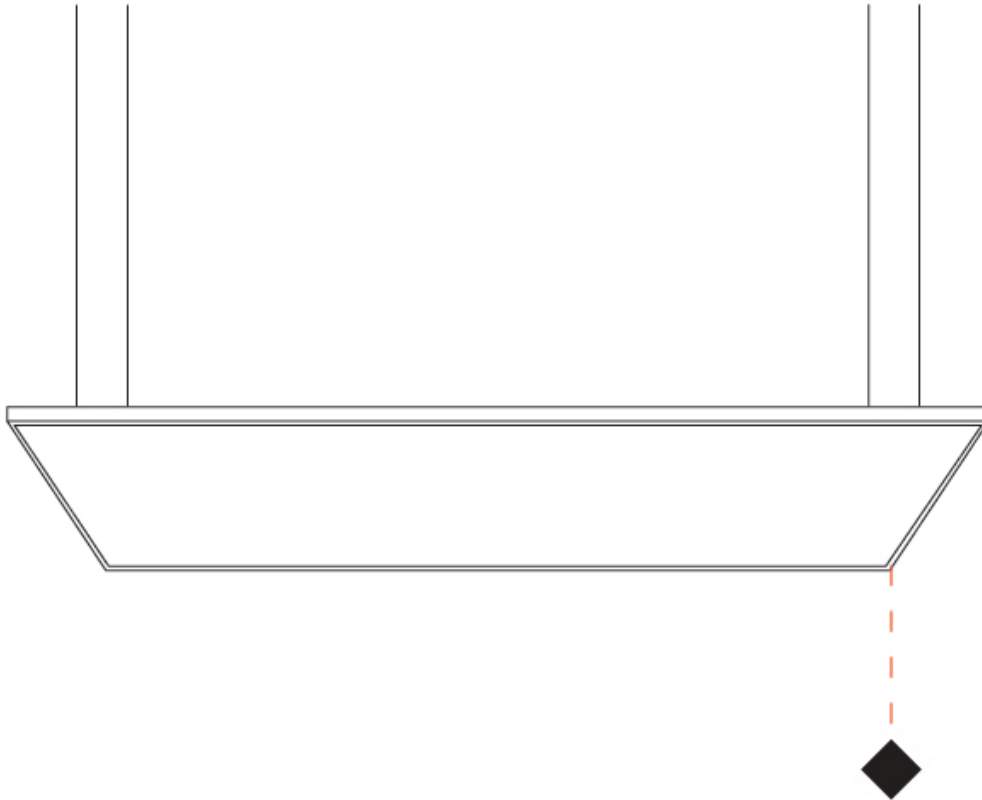

A

PROJECT	
TYPE	
SPECIFIER	
QUANTITY	
DATE	

HARMONY SQUARE SUSPENSION

A51080-

base number	Color	Finish	Diffuser
	Temperature	Options	Options

- To build a product code in our configurator select the specify button on the base model # product page
- To build a manual product code on this datasheet choose from the options listed below in blue font and add the suffix to the base model #

GENERAL

Series: Harmony Square
Partner: Ivela
Division: Architectural
Installation: Suspension
Product Type: Panels
Mounting Location: Ceiling
Light Distribution: Direct

PHYSICAL

Shape: Square
Length (mm): 1810
Length (in): 71 1/4
Width (mm): 1110
Width (in): 43 11/16
Height (mm): 27
Height (in): 1 1/16
Max. Overall Height (mm): 2500
Max. Overall Height (in): 98 7/16
Diffuser: PMMA - Opal / Prismatic
Fixture Finish: WHI / BLK / GLD
Fixture Material: Aluminum

ELECTRICAL

Lamp Type: LED
Input Wattage (W): 72
Dimming: Tri-Mode (Non-Dimming and Phase Dimming (120Vac only) and 0-10V Dimming)
Driver Included: No
Driver Location: Remote
Driver Type: Constant Voltage - Universal
Driver Class: Class 2
Housing: ENCP 5 (ERP) ENCP 8 (SC Power)
Input Voltage (V): 120 - 277
Output Voltage (V): 24

LED

Color Temperature (°K): 2700 / 3000 / 3500 / 4000
Max. Delivered Lumen (lm): 4320 / 4500 / 4634 / 4770
Nominal Lumen (lm): 7200 / 7500 / 7950
CRI: >93 CRI
Lamp Life (hrs): 50000

OPTICAL

RATINGS AND CERTIFICATIONS

Certified By: Certified for North American Standards
IP rating: IP20

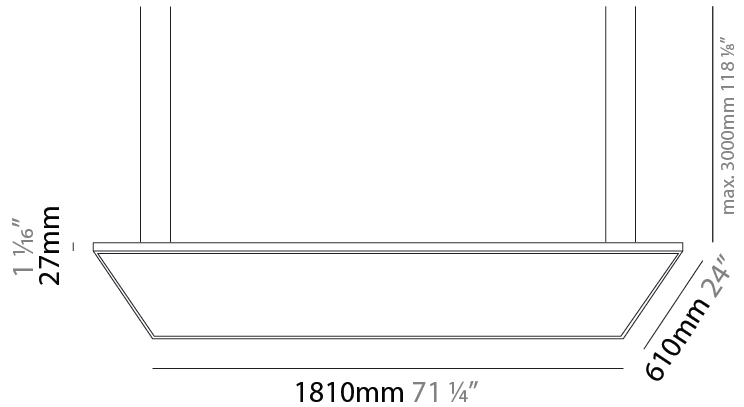

HARMONY SQUARE SUSPENSION

A51080-

PROJECT _____

TYPE _____

SPECIFIER _____

QUANTITY _____

DATE _____

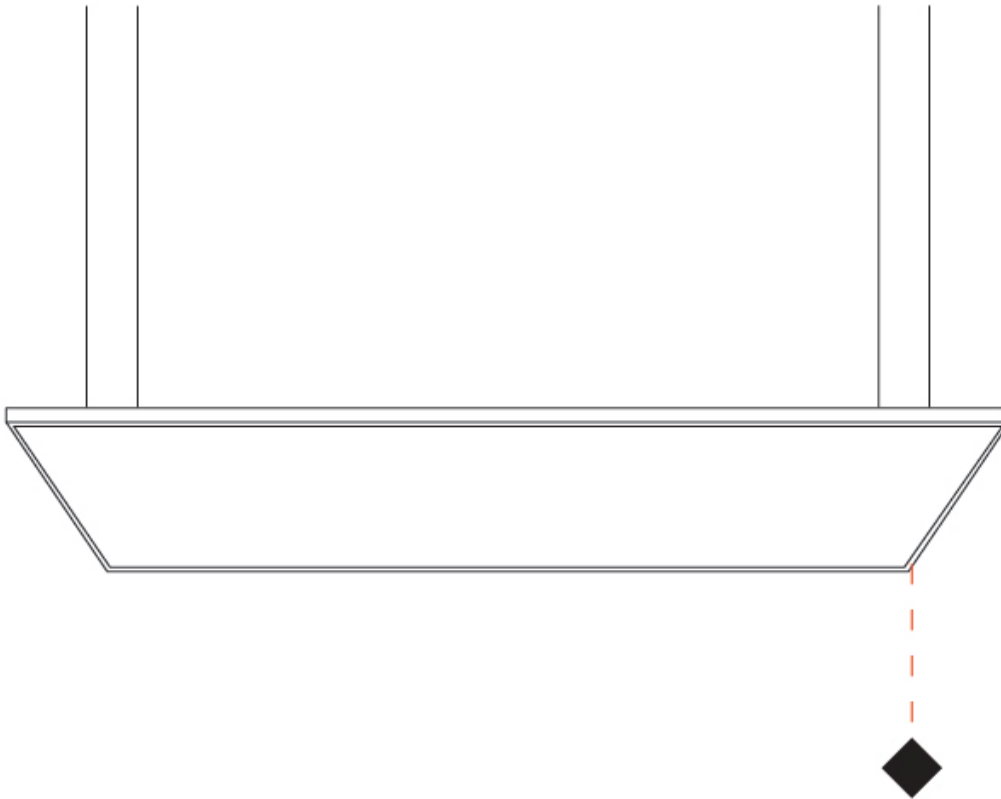

PROJECT	_____
TYPE	_____
SPECIFIER	_____
QUANTITY	_____
DATE	_____

HARMONY SQUARE SURFACE

A52046-

base number	Color	Finish	Diffuser
	Temperature	Options	Options

- To build a product code in our configurator select the specify button on the base model # product page
- To build a manual product code on this datasheet choose from the options listed below in blue font and add the suffix to the base model #

GENERAL

Series: Harmony Square
 Partner: Ivela
 Division: Architectural
 Installation: Surface
 Product Type: Panels
 Mounting Location: Ceiling
 Light Distribution: Direct

PHYSICAL

Shape: Square
 Length (mm): 610
 Length (in): 24
 Width (mm): 610
 Width (in): 24
 Height (mm): 27
 Height (in): 1 1/16
 Diffuser: PMMA - Opal
 Fixture Finish: WHI / BLK / GLD
 Fixture Material: Aluminum

ELECTRICAL

Lamp Type: LED
 Input Wattage (W): 48
 Dimming: Tri-Mode (Non-Dimming and Phase Dimming (120Vac only) and 0-10V Dimming)
 Driver Included: No
 Driver Location: Remote
 Driver Type: Constant Voltage - Universal
 Driver Class: Class 2
 Housing: ENCP 5 (ERP) ENCP 13 (SC Power)
 Input Voltage (V): 120 - 277
 Output Voltage (V): 24

LED

Color Temperature (°K): 2700 / 3000 / 4000
 Max. Delivered Lumen (lm): 3456 / 3600 / 3816
 Nominal Lumen (lm): 5760 / 6000 / 6360
 CRI: >93 CRI
 Lamp Life (hrs): 50000

OPTICAL

RATINGS AND CERTIFICATIONS

Certified By: CSA Certified to UL and CSA Standards
 IP rating: IP20

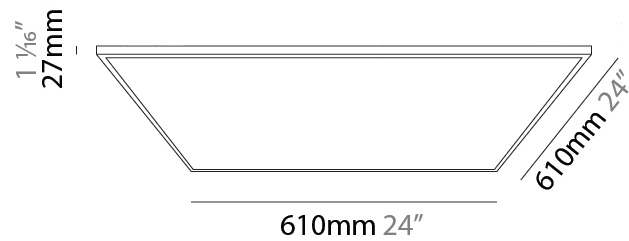
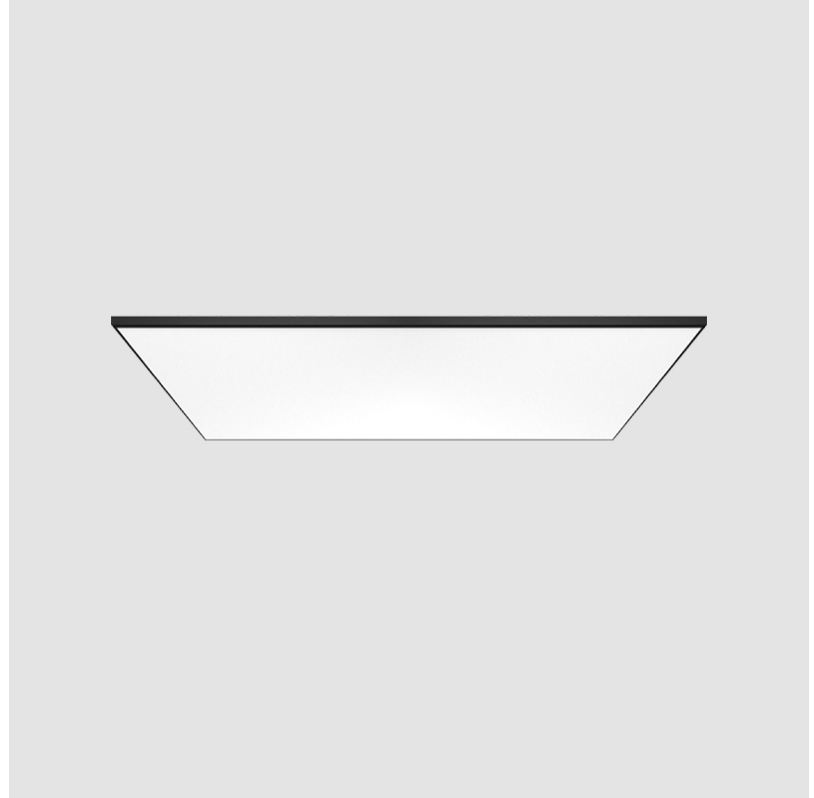

HARMONY SQUARE SURFACE

A52046-

PROJECT

TYPE

SPECIFIER

QUANTITY

DATE



PROJECT	_____
TYPE	_____
SPECIFIER	_____
QUANTITY	_____
DATE	_____

HARMONY SQUARE SURFACE

A52047-

base number	Color	Finish	Diffuser
	Temperature	Options	Options

- To build a product code in our configurator select the specify button on the base model # product page
- To build a manual product code on this datasheet choose from the options listed below in blue font and add the suffix to the base model #

GENERAL

Series: Harmony Square
Partner: Ivela
Division: Architectural
Installation: Surface
Product Type: Panels
Mounting Location: Ceiling
Light Distribution: Direct

PHYSICAL

Shape: Square
Length (mm): 910
Length (in): 35 ¹³ / ₁₆
Width (mm): 910
Width (in): 35 ¹³ / ₁₆
Height (mm): 27
Height (in): 1 ¹ / ₁₆
Diffuser: PMMA - Opal
Fixture Finish: WHI / BLK / GLD
Fixture Material: Aluminum

ELECTRICAL

Lamp Type: LED
Input Wattage (W): 72
Dimming: Tri-Mode (Non-Dimming and Phase Dimming (120Vac only) and 0-10V Dimming)
Driver Included: No
Driver Location: Remote
Driver Type: Constant Voltage - Universal
Driver Class: Class 2
Housing: ENCP 5 (ERP) ENCP 8 (SC Power)
Input Voltage (V): 120 - 277
Output Voltage (V): 24

LED

Color Temperature (°K): 2700 / 3000 / 4000
Max. Delivered Lumen (lm): 5184 / 5400 / 5724
Nominal Lumen (lm): 8640 / 9000 / 9540
CRI: >93 CRI
Lamp Life (hrs): 50000

OPTICAL

RATINGS AND CERTIFICATIONS

Certified By: CSA Certified to UL and CSA Standards
IP rating: IP20

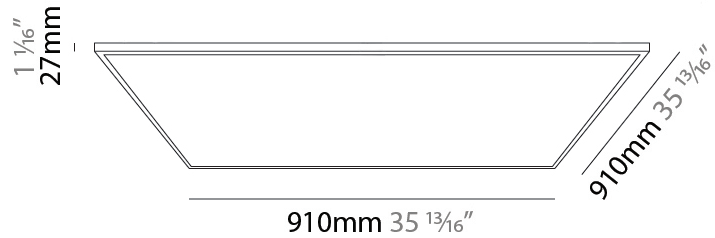
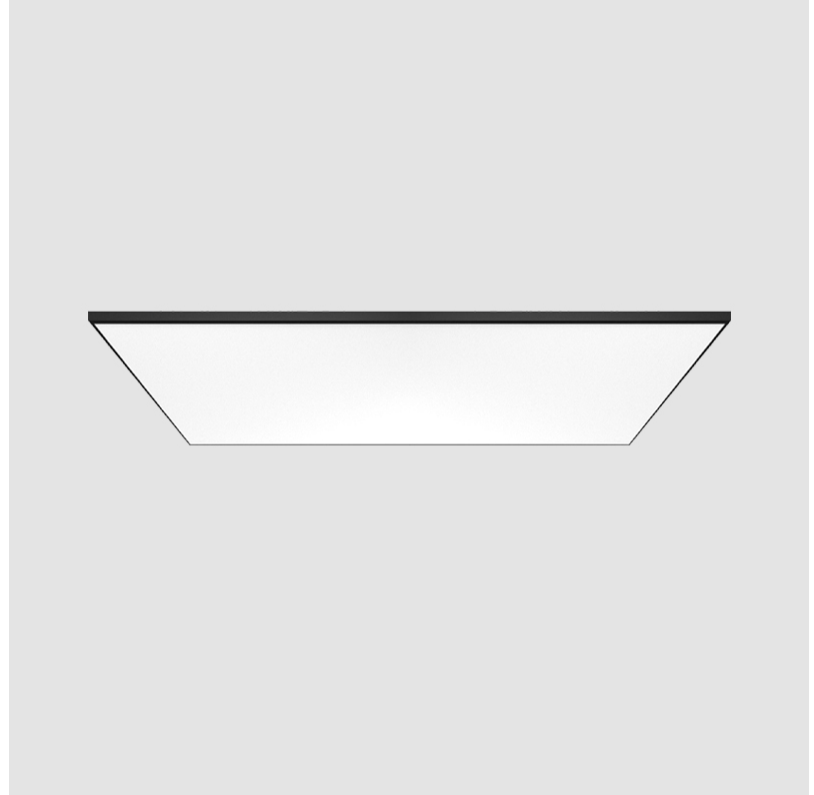

HARMONY SQUARE SURFACE

A52047-

PROJECT

TYPE

SPECIFIER

QUANTITY

DATE



PROJECT	_____
TYPE	_____
SPECIFIER	_____
QUANTITY	_____
DATE	_____

HARMONY SQUARE SURFACE

A52048-

base number	Color	Finish	Diffuser
	Temperature	Options	Options

- To build a product code in our configurator select the specify button on the base model # product page
- To build a manual product code on this datasheet choose from the options listed below in blue font and add the suffix to the base model #

GENERAL

Series: Harmony Square
Partner: Ivela
Division: Architectural
Installation: Surface
Product Type: Panels
Mounting Location: Ceiling
Light Distribution: Direct

PHYSICAL

Shape: Square
Length (mm): 1110
Length (in): 43 11/16
Width (mm): 1110
Width (in): 43 11/16
Height (mm): 27
Height (in): 1 1/16
Diffuser: PMMA - Opal
Fixture Finish: WHI / BLK / GLD
Fixture Material: Aluminum

ELECTRICAL

Lamp Type: LED
Input Wattage (W): 80
Dimming: Tri-Mode (Non-Dimming and Phase Dimming (120Vac only) and 0-10V Dimming)
Driver Included: No
Driver Location: Remote
Driver Type: Constant Voltage - Universal
Driver Class: Class 2
Housing: ENCP 5 (ERP) ENCP 8 (SC Power)
Input Voltage (V): 120 - 277
Output Voltage (V): 24

LED

Color Temperature (°K): 2700 / 3000 / 4000
Max. Delivered Lumen (lm): 6336 / 6600 / 6996
Nominal Lumen (lm): 10560 / 11000 / 11660
CRI: >93 CRI
Lamp Life (hrs): 50000

OPTICAL

RATINGS AND CERTIFICATIONS

Certified By: CSA Certified to UL and CSA Standards
IP rating: IP20

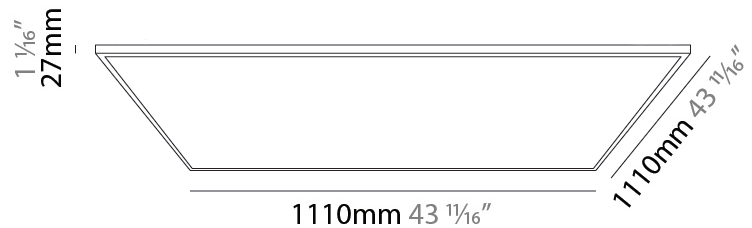
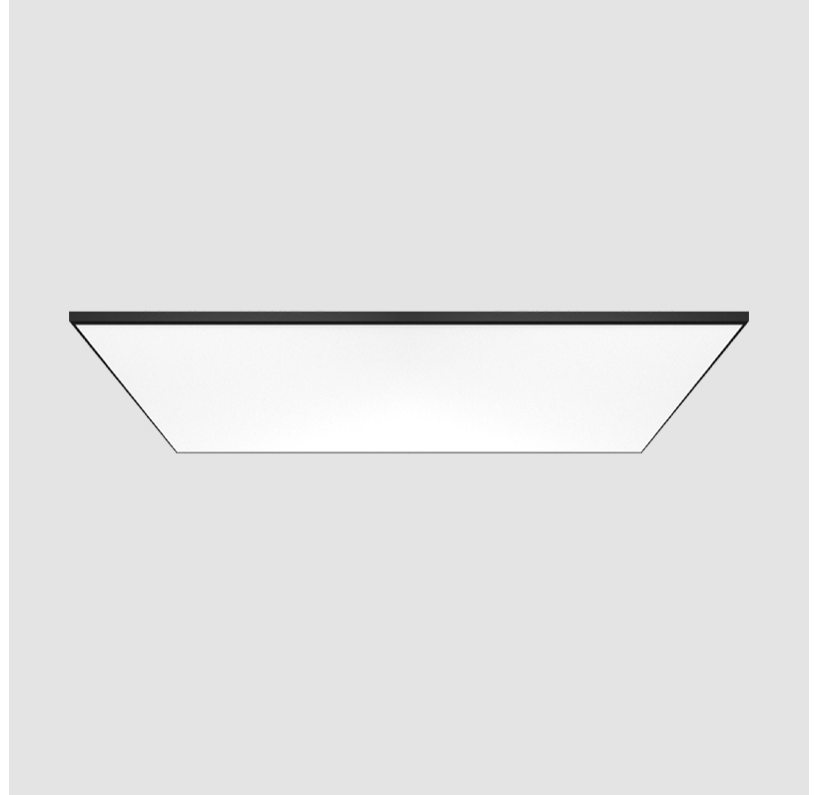

HARMONY SQUARE SURFACE

A52048-

PROJECT	_____
TYPE	_____
SPECIFIER	_____
QUANTITY	_____
DATE	_____



PROJECT	_____
TYPE	_____
SPECIFIER	_____
QUANTITY	_____
DATE	_____

HARMONY SQUARE SURFACE

A52049- - -
 base number Color Finish Diffuser
 Temperature Options Options

- To build a product code in our configurator select the specify button on the base model # product page
- To build a manual product code on this datasheet choose from the options listed below in blue font and add the suffix to the base model #

GENERAL

Series: Harmony Square
 Partner: Ivela
 Division: Architectural
 Installation: Surface
 Product Type: Panels
 Mounting Location: Ceiling
 Light Distribution: Direct

PHYSICAL

Shape: Square
 Length (mm): 1210
 Length (in): 47 5/8
 Width (mm): 610
 Width (in): 24
 Height (mm): 27
 Height (in): 1 1/16
 Diffuser: PMMA - Opal
 Fixture Finish: WHI / BLK / GLD
 Fixture Material: Aluminum

ELECTRICAL

Lamp Type: LED
 Input Wattage (W): 48
 Dimming: Tri-Mode (Non-Dimming and Phase Dimming (120Vac only) and 0-10V Dimming)
 Driver Included: No
 Driver Location: Remote
 Driver Type: Constant Voltage - Universal
 Driver Class: Class 2
 Housing: ENCP 5 (ERP) ENCP 13 (SC Power)
 Input Voltage (V): 120 - 277
 Output Voltage (V): 24

LED

Color Temperature (°K): 2700 / 3000 / 3500 / 4000
 Max. Delivered Lumen (lm): 3456 / 3600 / 3816
 Nominal Lumen (lm): 5760 / 6000 / 6178 / 6360
 CRI: >93 CRI
 Lamp Life (hrs): 50000

OPTICAL

RATINGS AND CERTIFICATIONS

Certified By: CSA Certified to UL and CSA Standards
 IP rating: IP20

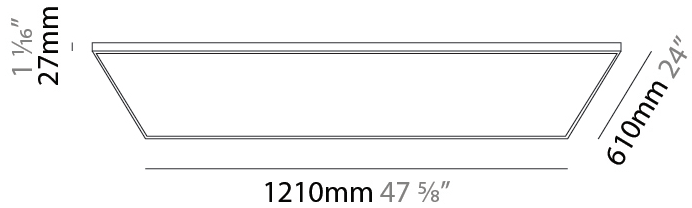
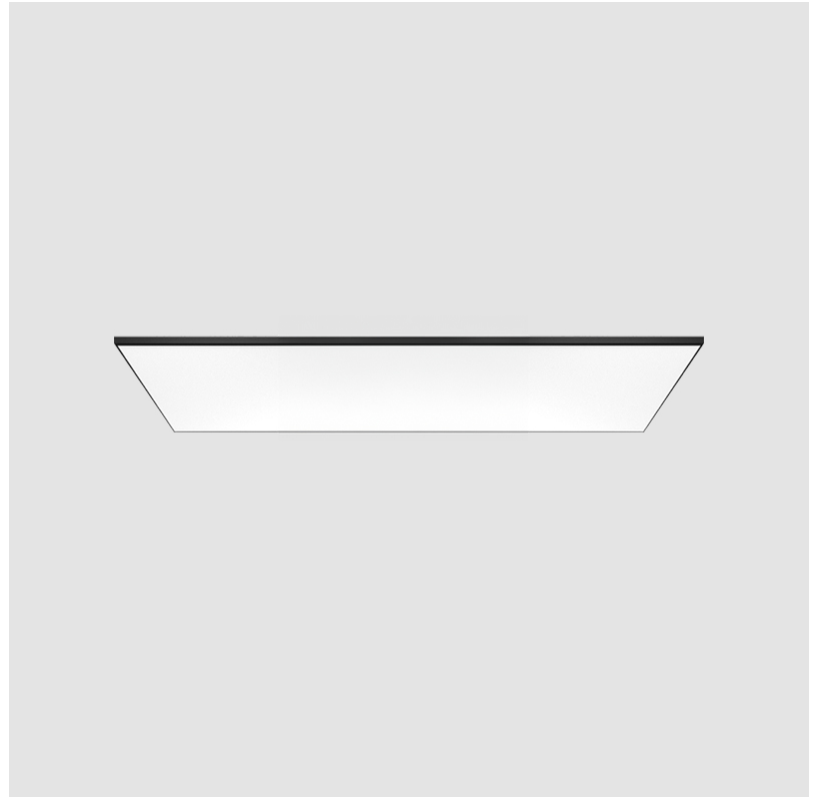

HARMONY SQUARE SURFACE

A52049-

PROJECT

TYPE

SPECIFIER

QUANTITY

DATE

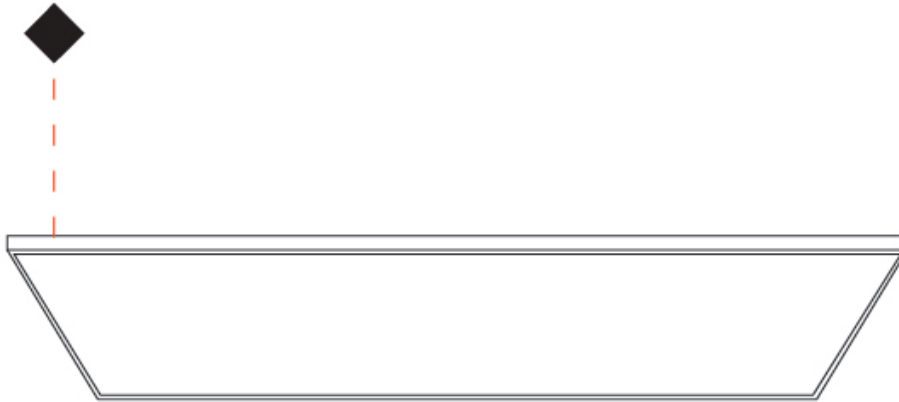

PROJECT	_____
TYPE	_____
SPECIFIER	_____
QUANTITY	_____
DATE	_____

HARMONY SQUARE SURFACE

A52050-

base number	Color	Finish	Diffuser
	Temperature	Options	Options

- To build a product code in our configurator select the specify button on the base model # product page
- To build a manual product code on this datasheet choose from the options listed below in blue font and add the suffix to the base model #

GENERAL

Series: Harmony Square
Partner: Ivela
Division: Architectural
Installation: Surface
Product Type: Panels
Mounting Location: Ceiling
Light Distribution: Direct

PHYSICAL

Shape: Square
Length (mm): 1510
Length (in): 59 7/16
Width (mm): 910
Width (in): 35 13/16
Height (mm): 27
Height (in): 1 1/16
Diffuser: PMMA - Opal
Fixture Finish: WHI / BLK / GLD
Fixture Material: Aluminum

ELECTRICAL

Lamp Type: LED
Input Wattage (W): 60
Dimming: Tri-Mode (Non-Dimming and Phase Dimming (120Vac only) and 0-10V Dimming)
Driver Included: No
Driver Location: Remote
Driver Type: Constant Voltage - Universal
Driver Class: Class 2
Housing: ENCP 5 (ERP) ENCP 8 (SC Power)
Input Voltage (V): 120 - 277
Output Voltage (V): 24

LED

Color Temperature (°K): 2700 / 3000 / 3500 / 4000
Max. Delivered Lumen (lm): 4320 / 4500 / 4634 / 4770
Nominal Lumen (lm): 7200 / 7500 / 7950
CRI: >93 CRI
Lamp Life (hrs): 50000

OPTICAL

RATINGS AND CERTIFICATIONS

Certified By: CSA Certified to UL and CSA Standards
IP rating: IP20

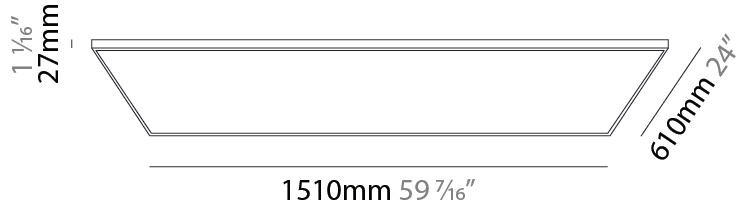
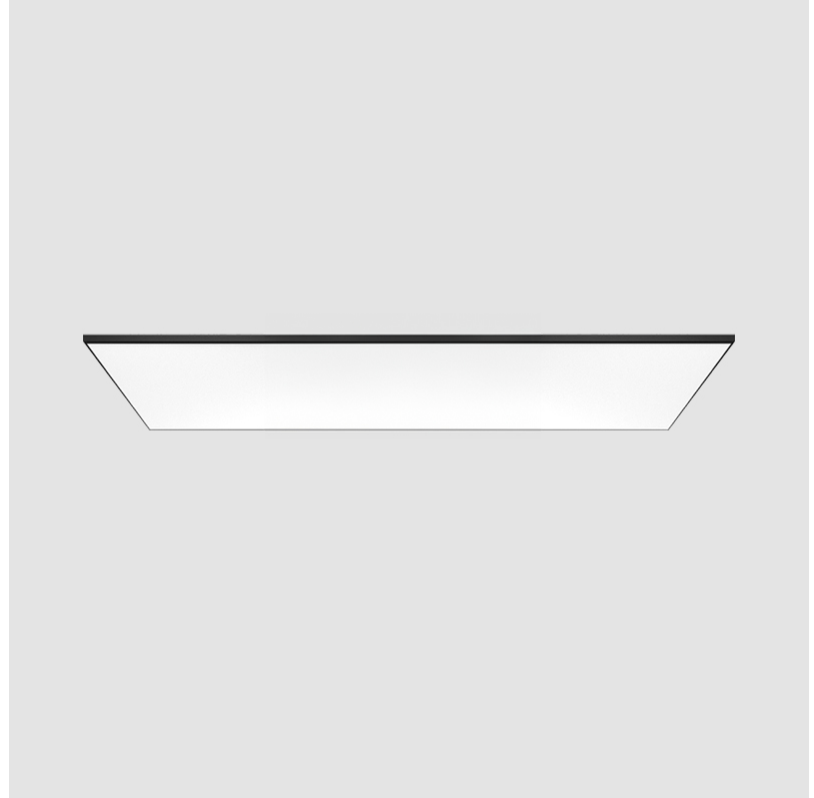

HARMONY SQUARE SURFACE

A52050-

PROJECT

TYPE

SPECIFIER

QUANTITY

DATE

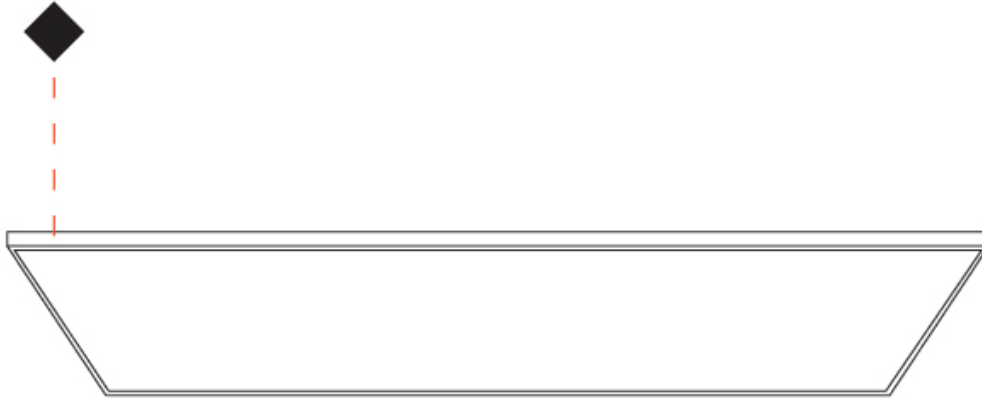

PROJECT	_____
TYPE	_____
SPECIFIER	_____
QUANTITY	_____
DATE	_____

HARMONY SQUARE SURFACE

A52051- - -
 base number Color Finish Diffuser
 Temperature Options Options

- To build a product code in our configurator select the specify button on the base model # product page
- To build a manual product code on this datasheet choose from the options listed below in blue font and add the suffix to the base model #

GENERAL

Series: Harmony Square
 Partner: Ivela
 Division: Architectural
 Installation: Surface
 Product Type: Panels
 Mounting Location: Ceiling
 Light Distribution: Direct

PHYSICAL

Shape: Square
 Length (mm): 1810
 Length (in): 71 1/4
 Width (mm): 610
 Width (in): 24
 Height (mm): 27
 Height (in): 1 1/16
 Diffuser: PMMA - Opal
 Fixture Finish: WHI / BLK / GLD
 Fixture Material: Aluminum

ELECTRICAL

Lamp Type: LED
 Input Wattage (W): 72
 Dimming: Tri-Mode (Non-Dimming and Phase Dimming (120Vac only) and 0-10V Dimming)
 Driver Included: No
 Driver Location: Remote
 Driver Type: Constant Voltage - Universal
 Driver Class: Class 2
 Housing: ENCP 5 (ERP) ENCP 8 (SC Power)
 Input Voltage (V): 120 - 277
 Output Voltage (V): 24

LED

Color Temperature (°K): 2700 / 3000 / 3500 / 4000
 Max. Delivered Lumen (lm): 4320 / 4500 / 4635 / 4770
 Nominal Lumen (lm): 7200 / 7500 / 7950
 CRI: >93 CRI
 Lamp Life (hrs): 50000

OPTICAL

RATINGS AND CERTIFICATIONS

Certified By: CSA Certified to UL and CSA Standards
 IP rating: IP20

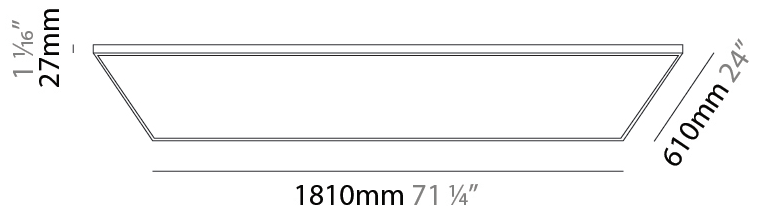
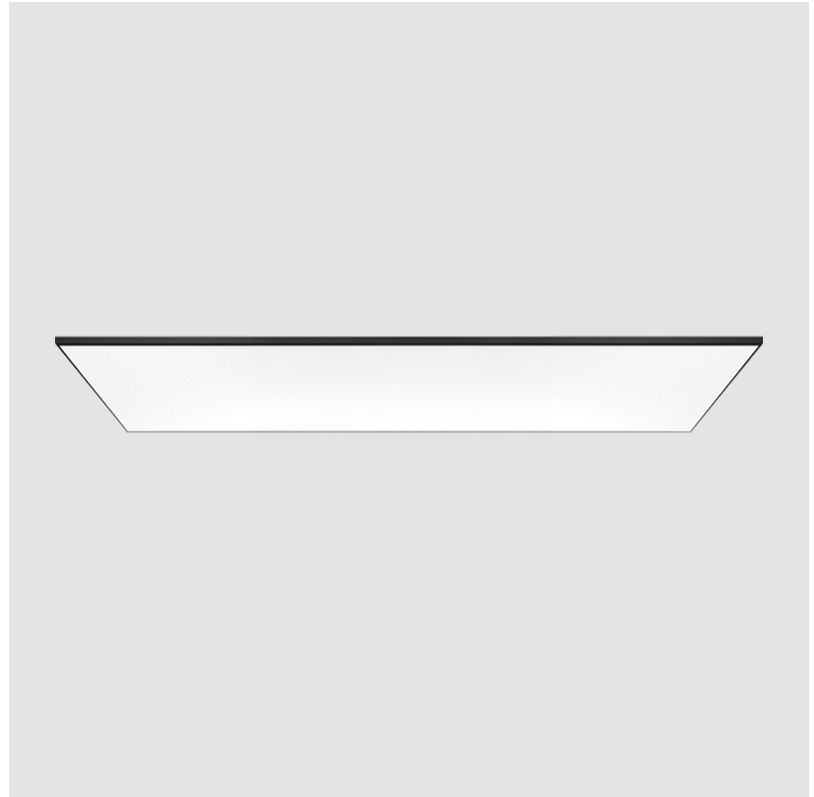

HARMONY SQUARE SURFACE

A52051-

PROJECT

TYPE

SPECIFIER

QUANTITY

DATE

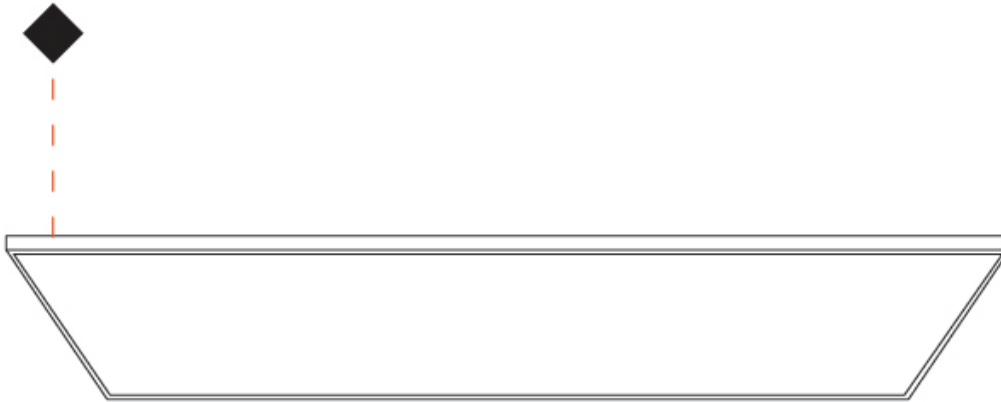

HARMONY SQUARE RECESSED

A56188- - -

base number Color Finish Diffuser
 Temperature Options Options

- To build a product code in our configurator select the specify button on the base model # product page
- To build a manual product code on this datasheet choose from the options listed below in blue font and add the suffix to the base model #

GENERAL

Series: Harmony Square
 Partner: Ivela
 Division: Architectural
 Installation: Recessed
 Product Type: Panels
 Mounting Location: Ceiling
 Light Distribution: Direct

PHYSICAL

Shape: Square
 Length (mm): 610
 Length (in): 24
 Width (mm): 610
 Width (in): 24
 Height (mm): 27
 Height (in): 1 ¹/₁₆
 Diffuser: PMMA - Opal
 Fixture Finish: WHI / BLK / GLD
 Fixture Material: Aluminum

ELECTRICAL

Lamp Type: LED
 Input Wattage (W): 48
 Dimming: Tri-Mode (Non-Dimming and Phase Dimming (120Vac only) and 0-10V Dimming)
 Driver Included: No
 Driver Location: Remote
 Driver Type: Constant Voltage - Universal
 Driver Class: Class 2
 Housing: ENCP 5 (ERP) ENCP 13 (SC Power)
 Input Voltage (V): 120 - 277
 Output Voltage (V): 24

LED

Color Temperature (°K): 2700 / 3000 / 3500 / 4000
 Max. Delivered Lumen (lm): 3456 / 3600 / 3707 / 3816
 Nominal Lumen (lm): 5760 / 6000 / 6178 / 6360
 CRI: >93 CRI
 Lamp Life (hrs): 50000

OPTICAL

RATINGS AND CERTIFICATIONS

Certified By: CSA Certified to UL and CSA Standards
 IP rating: IP20

PROJECT
TYPE
SPECIFIER
QUANTITY
DATE

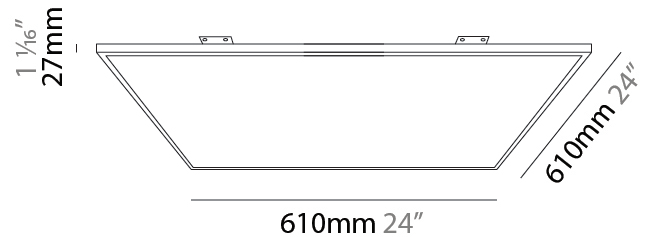

HARMONY SQUARE RECESSED

A56188-

PROJECT

TYPE

SPECIFIER

QUANTITY

DATE

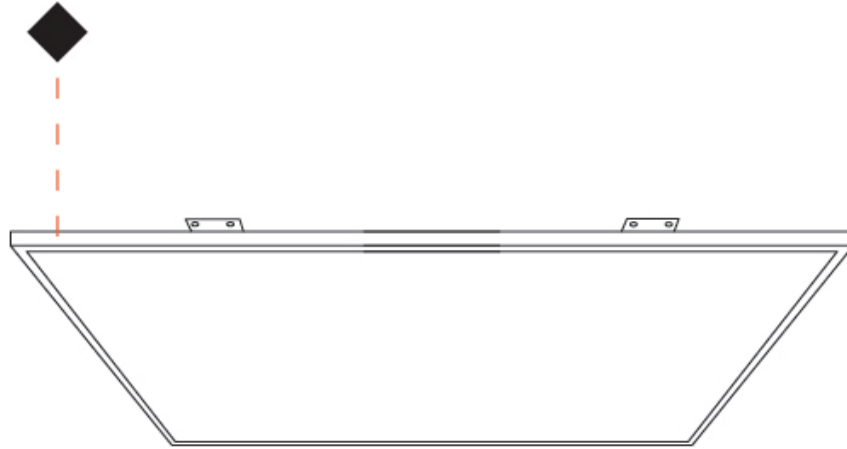

PROJECT	_____
TYPE	_____
SPECIFIER	_____
QUANTITY	_____
DATE	_____

HARMONY SQUARE RECESSED

A56189-

base number	Color	Finish	Diffuser
	Temperature	Options	Options

- To build a product code in our configurator select the specify button on the base model # product page
- To build a manual product code on this datasheet choose from the options listed below in blue font and add the suffix to the base model #

GENERAL

Series: Harmony Square
Partner: Ivela
Division: Architectural
Installation: Recessed
Product Type: Panels
Mounting Location: Ceiling
Light Distribution: Direct

PHYSICAL

Shape: Square
Length (mm): 910
Length (in): 35 ¹³ / ₁₆
Width (mm): 910
Width (in): 35 ¹³ / ₁₆
Height (mm): 27
Height (in): 1 ¹ / ₁₆
Diffuser: PMMA - Opal
Fixture Finish: WHI / BLK / GLD
Fixture Material: Aluminum

ELECTRICAL

Lamp Type: LED
Input Wattage (W): 72
Dimming: Tri-Mode (Non-Dimming and Phase Dimming (120Vac only) and 0-10V Dimming)
Driver Included: No
Driver Location: Remote
Driver Type: Constant Voltage - Universal
Driver Class: Class 2
Housing: ENCP 5 (ERP) ENCP 8 (SC Power)
Input Voltage (V): 120 - 277
Output Voltage (V): 24

LED

Color Temperature (°K): 2700 / 3000 / 3500 / 4000
Max. Delivered Lumen (lm): 5184 / 5400 / 5560 / 5724
Nominal Lumen (lm): 8640 / 9000 / 9268 / 9540
CRI: >93 CRI
Lamp Life (hrs): 50000

OPTICAL

RATINGS AND CERTIFICATIONS

Certified By: CSA Certified to UL and CSA Standards
IP rating: IP20

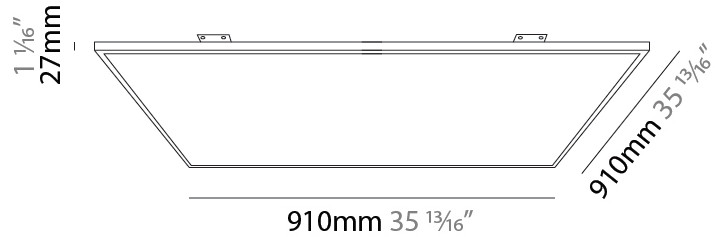
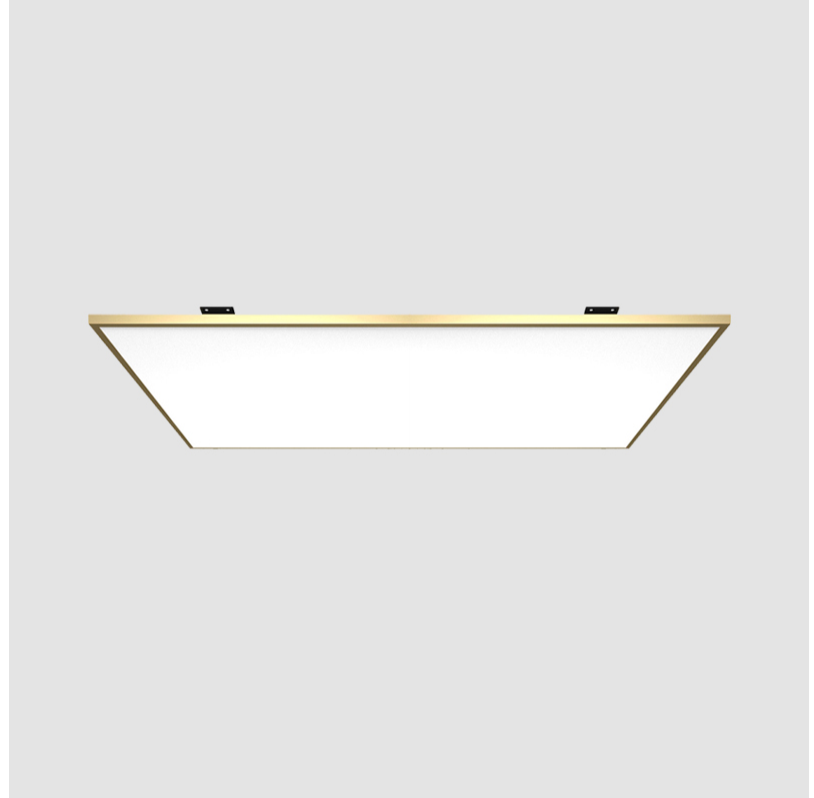

HARMONY SQUARE RECESSED

A56189-

PROJECT	_____
TYPE	_____
SPECIFIER	_____
QUANTITY	_____
DATE	_____



PROJECT	_____
TYPE	_____
SPECIFIER	_____
QUANTITY	_____
DATE	_____

HARMONY SQUARE RECESSED

A56190-

base number	Color	Finish	Diffuser
	Temperature	Options	Options

- To build a product code in our configurator select the specify button on the base model # product page
- To build a manual product code on this datasheet choose from the options listed below in blue font and add the suffix to the base model #

GENERAL

Series: Harmony Square
Partner: Ivela
Division: Architectural
Installation: Recessed
Product Type: Panels
Mounting Location: Ceiling
Light Distribution: Direct

PHYSICAL

Shape: Square
Length (mm): 1110
Length (in): 43 11/16
Width (mm): 1110
Width (in): 43 11/16
Height (mm): 27
Height (in): 1 1/16
Diffuser: PMMA - Opal
Fixture Finish: WHI / BLK / GLD
Fixture Material: Aluminum

ELECTRICAL

Lamp Type: LED
Input Wattage (W): 80
Dimming: Tri-Mode (Non-Dimming and Phase Dimming (120Vac only) and 0-10V Dimming)
Driver Included: No
Driver Location: Remote
Driver Type: Constant Voltage - Universal
Driver Class: Class 2
Housing: ENCP 5 (ERP) ENCP 8 (SC Power)
Input Voltage (V): 120 - 277
Output Voltage (V): 24

LED

Color Temperature (°K): 2700 / 3000 / 3500 / 4000
Max. Delivered Lumen (lm): 6336 / 6600 / 6796 / 6996
Nominal Lumen (lm): 10560 / 11000 / 11327 / 11660
CRI: >93 CRI
Lamp Life (hrs): 50000

OPTICAL

RATINGS AND CERTIFICATIONS

Certified By: CSA Certified to UL and CSA Standards
IP rating: IP20

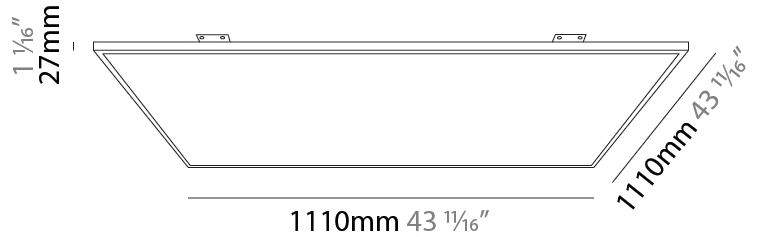

HARMONY SQUARE RECESSED

A56190-

PROJECT	_____
TYPE	_____
SPECIFIER	_____
QUANTITY	_____
DATE	_____



HARMONY SQUARE COLOR FINISH CHART

PROJECT _____

TYPE _____

SPECIFIER _____

QUANTITY _____

DATE _____

Fixture Finish

White - WHI

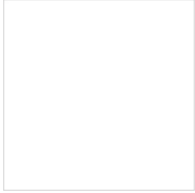

Black - BLK

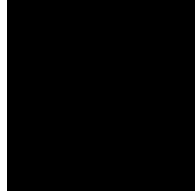

Gold - GLD



Digital: Not all screens are calibrated the same, and therefore, colors will appear differently between screens.

Physical: When texture is involved, there will be variations in color, character and tone within a product series and between product families.



LEGEND

	floor-mounted		pivotable		special LED (upon request) RGB, RGBW, tunable, gold+, meat+, art+, fashion+
	wall and ceiling: recessed and surface mounted		rotating		warm dim / natural dimming LED
	ceiling-mounted and wall-mounted		illuminate tilted		rechargeable battery powered
	wall-mounted		color of suspension cable		fixture with natural vivid LED (upon request)
	omni-directional light distribution		length of suspension cable		color rendering index
	direct light distribution		reflector degree selection		color temperature
	direct/indirect light distribution		super spot		lumen (luminous flux)
	indirect light distribution		lens		efficacy (lumens per watt)
	asymmetric light distribution		lens pack		Unified Glare Rating (UGR) range from 5-40
	aura light distribution		shine ring		marine grade (AISI 316 stainless steel)
	round wall or ceiling cut-out		integrated shine ring with diffuser		walk on
	square wall or ceiling cut-out		free individual colors 01-29		drive on
	the supplied jig specifies the cutout dimensions		individual colors: 00 (free of charge), 01-25 (extra charge)		Dark Sky Compliance
	minimum distance (meters) lamp - object		luminaire part to be colored (F1)		Americans with Disabilities Act (less than 4" off the wall located between 27"-84" from floor)
	recessed depth		luminaire part to be colored (F2)		lamp protected against explosion
	ceiling thickness in mm		luminaire part to be colored (F3)		blown glass using traditional methods by master glass blower
	ceiling thickness selection		luminaire part to be colored (F4)		acoustic material
	dimmable DP (phase), DV (0-10V), DD (dali), DS (step-dim)		luminaire part to be colored (F5)		protection class I, protection insulation
	included or excluded LED driver/transformer/control gear		color of 3-circuit adaptor		protection class II, protection insulation
	separately switchable		indirect diffuser		ETL Certified to UL and CSA Standards
	sensor		direct diffuser		UL Certified to UL and CSA Standards
	remote control		ball-proof (upon request)		CSA Certified to UL and CSA Standards
	available upon request		accessory		Certified for North American Standards

IP RATING

	protected against ingress of solid bodies greater than 12.5mm (finger)
	protected against ingress of solid bodies greater than 2.5mm protected against sprays of water up to 60 degrees from the vertical (rain)
	protected against ingress of solid bodies greater than 1mm (wire) no protection against the ingress of moisture
	protected against ingress of solid bodies greater than 1mm (wire) protected against sprays of water up to 60 degrees from the vertical (rain)
	protected against ingress of solid bodies greater than 1mm (wire) protected against water splashed from all directions
	protected against limited ingress of dust (wet rooms/covered outdoor areas) protected against water splashed from all directions
	protected against ingress of dust protected against jets of water
	protected against ingress of dust protected against powerful jets of water or heavy seas
	protected against ingress of dust protected against immersion of water between 15cm - 1m for 30 minutes
	protected against ingress of dust protected against immersion of water under pressure for long periods

IK RATING

	protected against 0.14 joules impact (equivalent to 0.25kg mass dropped from 56mm above the surface)
	protected against 0.2 joules impact (equivalent to 0.25kg mass dropped from 80mm above the surface)
	protected against 0.35 joules impact (equivalent to 0.25kg mass dropped from 140mm above the surface)
	protected against 0.5 joules impact (equivalent to 0.25kg mass dropped from 200mm above the surface)
	protected against 0.7 joules impact (equivalent to 0.25kg mass dropped from 280mm above the surface)
	protected against 1 joules impact (equivalent to 0.25kg mass dropped from 400mm above the surface)
	protected against 2 joules impact (equivalent to 0.5kg mass dropped from 400mm above the surface)
	protected against 5 joules impact (equivalent to 1.7kg mass dropped from 300mm above the surface)
	protected against 10 joules impact (equivalent to 5.0kg mass dropped from 200mm above the surface)
	protected against 20 joules impact (equivalent to 5.0kg mass dropped from 400mm above the surface)